



**Blaster™
Operation and
Maintenance
Manual**



Registration Data Sheet

Register your spreader at www.meyerproducts.com

Owner Name _____

Address _____

City _____

State/Province _____ Zip/Postal Code _____

Purchased From Company Name _____

Contact Name _____

Address _____

City _____

State/Province _____ Zip/Postal Code _____

Phone Number (_____) _____

E-mail _____

Date Purchased _____

Vehicle Make _____ Vehicle Model _____

Vehicle Year _____ Spreader Model _____

Spreader Serial Number _____





Thank You...

Thank you for buying your Meyer Spreader. As a new owner of hard-working, mechanical equipment, we strongly urge you to spend quality time with this owner's manual. It's easy to use and full of time-saving tips that will enhance your ownership experience. It includes suggestions for faster installation, safe operation and more productive spreading.

We also strongly urge you to register your new Meyer spreader at meyerproducts.com. Registering will only take minutes and the benefits of doing so will last for years. When registered, you will receive timely and accurate communication on operation tips, maintenance, new products, and service bulletins. And in the unlikely event you need warranty work performed, your local servicing dealer will be able to process your claim faster.

*Thanks again for your business. You can now look forward to many years of reliable performance. If you have any questions about your Meyer spreader, contact us at: **www.meyerproducts.com** or call **216-486-1313**.*

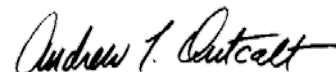

Andy Outcalt, President, Meyer Products, LLC.

Table of Contents

Registration Data Sheet	1
Thank You	2
Introduction / EC Declaration of Conformity	4
Safety Definitions & Warnings	5-7
Safety Decal Locations	8-9
Vehicle Requirements for Installation	10
Receiver Mount Installation/Assembly	12-13
Spreader Component Identification.....	14-17
Electrical Installation	18
Spreader Operation	19-20
Spreader Maintenance	21
Spreader Troubleshooting.....	22
Materials Chart	23
Spreader Calibration	24-25
Accessories.....	26-29
Warranty/Contact Meyer.....	30-31

Introduction

Snow and ice, despite the beauty it may impart to a bleak winter landscape, poses the dual threat of inconvenience and danger. The environmental conditions associated with snow and ice, not to mention the health hazards and economic loss it may impose, seriously endanger thousands of lives annually. Business and industry suffer, and millions of snowbelt residents may be affected by a single snowstorm.

Meyer Products LLC has published this manual to help you get the maximum performance from your Meyer spreader and familiarize you with the features designed for efficiency and safety; be sure you recognize and understand them. Follow recommended operation and maintenance instructions, so when the storm hits, your Meyer spreader will be ready and you will know how to spread like a pro.

DO NOT EQUIP ANY VEHICLE WITH A SPREADER WITHOUT CONSULTING VEHICLE MANUFACTURERS' RECOMMENDATIONS.

Vehicles equipped with Meyer spreaders installed may be so equipped as to meet vehicle manufacturers' specifications and recommended options for material spreading use. **Most vehicle manufacturers insist that vehicles which are to be used for ice control be equipped with certain options and accessories, and it is so stated in vehicle manufacturer specifications for snow plow application.**

WARNING: Deployment of an air bag while using a Meyer Spreader will not be covered under Meyer Products' warranty. We also recommend that, for optimum performance, vehicles used for ice control be equipped with:

- Four-Wheel Drive
- Minimum 60 Amp Alternator or larger
- Minimum 70 Amp Battery or larger (550 C.C.A.)
- Mud and Snow Tires
- Increased Radiator Cooling
- Automatic Transmission
- Power Brakes
- Power Steering

Under the continuing Meyer Product Improvement Plan, Meyer Products LLC reserves the right to change design details and construction without prior notice and without incurring any obligation.

EC Declaration of Conformity

EC DECLARATION OF CONFORMITY

The undersigned representing the manufacturer

and the authorized representative
established within the community

herewith declared that the Product: **Snow & Ice Equipment**

Model/Type ref.:

is in conformity with the Essential requirements of the following EC Directives when subject to correct installation, maintenance and use conforming to its(their)intended purpose, to the applicable regulations and standards, to our operation and maintenance manual.

2006/95/EC	EC Low Voltage Directive
2004/108/EC	EMC Directive
2006/42/EC	Machinery Directive

and that the Standards and/or technical specifications referenced below have been applied:

- χ BS EN 60204-1:2006 / IEC 60204-1:2005: Safety of machinery – Electrical equipment of machines-Part 1: General requirements.
- χ EN ISO 12100-1:2003:Safety of Machinery – Basic Concepts, General Principles of Design Part 1: Basic Terminology and Methodology
- χ EN ISO 12100-2:2003:Safety of Machinery – Basic Concepts, General Principles of Design Part 2: Technical principles
- χ EN 13021:2003+A1- Winter service machines - Safety requirements
- χ EN 61000-6-2: 2005. Generic standards – Immunity for Industrial Environments.
- χ EN 61000-6-4:2005. Generic emission standard, Part 2: Industrial environment.

Year of CE Marking:

Manufacturer:

Authorized Representative in the community:

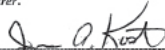
Signature: 
Position: SENIOR TECHNICAL MANAGER
Date: 5-14-2010
Place: CLEVELAND, OHIO

Signature _____
Position _____
Date _____
Place _____

Safety Definitions

These safety alert decals are used to alert you of potential personal injury hazards. Obey all safety messages that follow this symbol to avoid possible injury or death.



DANGER Conveyor

This decal alerts all to the danger of serious personal injury or death while servicing or cleaning this equipment without first turning off or disconnecting all power sources.



DANGER Spinner

This decal alerts all to the danger of any person being near the spinner while it is turning where serious personal injury could result if struck by flying debris.



CAUTION

This decal cautions all to the risk of the tank containing hazardous chemicals. Operators should wear appropriate PPE when contact with chemicals is possible.



CAUTION

This decal cautions all to observe general safety procedures when operating, moving, storing, cleaning or servicing this equipment.



CAUTION Empty Hopper

This decal cautions all to only lift or move equipment when hopper is empty to prevent the risk of serious personal injury or property damage.

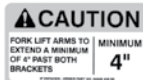

CAUTION Fork Length

This decal cautions all to make sure fork lift arms extend a minimum of 4"(10.2cm) past both brackets before lifting or moving equipment to prevent the risk of serious personal injury or property damage.



Safety Definitions & Warnings

SAFETY DEFINITIONS



This is the safety alert symbol. It is used to alert you to potential personal injury hazards. Obey all safety messages that follow this symbol to avoid possible injury or death.



DANGER Indicates an imminently hazardous situation which, if not avoided, will result in death or serious injury.



WARNING Indicates a potentially hazardous situation which, if not avoided, could result in death or serious injury.















CAUTION Indicates a potentially hazardous situation which, if not avoided, may result in minor or moderate injury.



CAUTION used without the safety alert symbol indicates a potentially hazardous situation which, if not avoided, will result in property damage.

1		NEVER stand or ride on the spreader. Failure to comply will result in death or serious injury.
2		Keep hands, feet, and clothing away from power driven parts. Failure to comply will result in death or serious injury.
3		Make sure spreader is completely shut off and all movement has stopped before attempting to clean, service or unclog. Failure to comply will result in death or serious injury.
4		NEVER enter hopper while spreader is operating or capable of being operated. Failure to comply will result in death or serious injury.
5		NEVER operate or service your spreader without first CAREFULLY reading the Owner's Manual. It is CRITICAL for your safety to ALWAYS obey EVERY warning in the manual and follow EVERY instruction EXPLICITLY . Failure to comply could result in death or serious injury.
6		Never leave operator's position without first completely turning off spreader, disengaging PTO, shutting off hydraulic valve and setting vehicle parking brake. Failure to comply will result in death or serious injury.
7		Never operate spreader without all shields, guards, and safety decals in place. Failure to comply will result in death or serious injury.
8		Spreader should only be operated by personnel trained in the safe use and transportation of this equipment.
9		The spreader should NEVER be used for any other purpose other than spreading ice melting or traction products on streets, parking lots and driveways. Failure to comply will result in property damage, death or serious injury.
10		Inspect spreader assembly and mounting components and fasteners for wear and damage before and after each use. Worn or damaged components or fasteners could allow spreader to break free from the transport vehicle. Failure to comply will result in death or serious injury.
11		Transport vehicle must not be operated when overloaded. In all cases, the loaded vehicle weight, including the entire spreader system, all aftermarket accessories, driver, passenger, options, nominal fluid levels, and cargo must not exceed the front/rear Gross Axle Weight Rating (GAWR), and total Gross Vehicle Weight Rating (GVWR). These weights ratings are specified on the safety compliance certification label on the driver's side door opening. Failure to comply will result in death or serious injury.
12		Spreader may tip over or fall. Spreader should be solidly supported when being mounted, dismounted, moved, or stored. Failure to comply will result in death or serious injury.
13		Operator, bystanders and pets should be kept at least 50 feet away from spreader during operation. Failure to comply will result in death or serious injury.
14		SAFETY PRECAUTIONS should be used when hydraulic system is operating or being serviced. Hydraulic fluid under pressure can cause a skin injection injury. If you are injured by hydraulic fluid, get medical attention immediately. Failure to comply will result in death or serious injury.
15		Engine exhaust contains lethal fumes. Breathing these fumes, even in low concentrations, can cause death. Never operate engine in an enclosed area without venting the exhaust to the outside. Failure to comply will result in death or serious injury.

Safety Definitions & Warnings

16		Gasoline is highly flammable and gasoline vapor is explosive. Never smoke while working on vehicle or spreader. Keep all open flames away from gasoline tank and lines. Wipe up any spilled gasoline immediately. Failure to comply will result in death or serious injury.
17		NEVER operate the spreader gasoline engine without first CAREFULLY reading the Owner's Manual. It is CRITICAL for your safety to ALWAYS obey EVERY warning in the manual and follow EVERY instruction EXPLICITLY. Failure to comply will result in death or serious injury.
18		A driver's first responsibility is the safe operation of the vehicle and spreader. The most important thing you can do to prevent a crash is to avoid distractions and pay attention to the road. Wait until it is safe to operate mobile communication equipment such as cell phones, two way radios, etc. Failure to comply will result in injury.
19		Vehicle must conform to all local, state, and national regulations regarding the use of reflective markings and flashing lights. Failure to comply will result in injury.
20		Batteries normally produce explosive gases which can cause personnel injury. Therefore, do not allow flames, sparks or lit tobacco to come near the battery. When charging or working near a battery, always cover your face and protect your eyes, and also provide ventilation. Batteries contain sulfuric acid which burns skin, eyes, and clothing. Failure to comply will result in injury.
21		Never transport spreader with spinner in the raised position. Failure to comply will result in property damage.
22		Installation of a Meyer spreader may affect your new vehicle warranty. Before beginning spreader installation verify mounting method is acceptable to your vehicle manufacturer. Failure to comply will result in property damage.
23		Warranty does not apply to a Meyer spreader product which has been negligently or improperly assembled or installed. Failure to comply will result in property damage.
24		CAUTION: To avoid harm to vehicles electrical system always disconnect battery before beginning installation. DO NOT BURN holes or WELD vehicle frame. This may cause frame failure. Failure to comply will result in property damage.
25		CAUTION: To avoid harm to spreader electrical system always disconnect battery before beginning installation or service. Do not operate spreader with a missing, discharged or dead battery. Failure to comply will result in property damage.
26		The Meyer spreader electrical system contains several automotive style fuses. If a problem should occur and fuse replacement is necessary, the replacement fuse must be of the same type and amperage as the original. Installing a fuse with a higher rating can damage the system and could cause a fire. Failure to comply will result in property damage.
27		Spreader is not designed to be chassis mounted. Do not support spreader by body jacks alone. Spreader must be installed directly onto truck bed. Failure to comply will result in property damage.

SAFETY DEFINITIONS



This is the safety alert symbol. It is used to alert you to potential personal injury hazards. Obey all safety messages that follow this symbol to avoid possible injury or death.



DANGER Indicates an imminently hazardous situation which, if not avoided, will result in death or serious injury.



WARNING Indicates a potentially hazardous situation which, if not avoided, could result in death or serious injury.



CAUTION Indicates a potentially hazardous situation which, if not avoided, may result in minor or moderate injury.



CAUTION used without the safety alert symbol indicates a potentially hazardous situation which, if not avoided, will result in property damage.

Safety Decal Locations

These safety alert decals are used to alert you of potential personal injury hazards. Obey all safety messages that follow the symbol to avoid possible injury or death.

WARNING Before operating READ and UNDERSTAND this operators manual in its entirety.

WARNING NEVER operate equipment while under the influence of alcohol, drugs, or medications that might impair your judgment and reaction time.

WARNING NEVER allow children to operate equipment. ALWAYS CHECK AREAS to be spread to be sure no hazardous conditions or substances are present. ALWAYS INSPECT UNIT FOR DEFECTS: broken, bent, or worn parts, or weakened areas on spreader or mount.

WARNING ALWAYS SHUT OFF vehicle power source before attaching, detaching, or servicing the equipment.

WARNING ALWAYS MAKE SURE PERSONNEL ARE CLEAR of spread pattern when using equipment.

WARNING NEVER EXCEED 45 M.P.H when loaded spreader is attached to vehicle. Braking distances and handling characteristics may be impaired at greater speeds.

CAUTION Never use wet materials or material with foreign debris. This unit is designed to handle clean, dry, free-flowing material.

Safety Decal Locations



CAUTION Never leave material in hopper for long periods of time. All ice melt materials will attract atmospheric moisture and may clump together.

WARNING INSPECT pins and bolts whenever attaching, detaching, and before travel. All factory installed bolts utilize lock nuts however road and operational vibrations might loosen them.

WARNING INSPECT unit periodically for defects. Parts that are broken, worn, or missing must be replaced immediately. The unit or any part of it should NOT be altered in any way without prior written permission from the manufacturer.

WARNING When using swing mount, NEVER swing spreader with material in hopper!

WARNING NEVER attempt to clear a jammed feed screw with the power on!

WARNING NEVER place hands into hopper or around feed screw and spinner when power is on. Also, keep loose clothing and hair away from moving parts!

CAUTION De-icing materials can be damaging to plant life and concrete. Know what you are spreading and where you are spreading it.

Vehicle Requirements for Installation

For installation Blaster 750 series spreaders:

1. Due to the size and capacity of these spreaders we recommend installation on full size trucks with a 1/2 Ton rating or higher.
2. This product line can be installed on any vehicle with a class 3 hitch receiver that will accept a 2" square tube.
3. If your vehicle is not factory equipped with a hitch, we recommend taking it to a reputable trailer hitch installation shop or your vehicles dealership.

1. This product line can be installed on any vehicle with a class 3 hitch receiver that will accept a 2" square tube and has a tongue weight rating of at least 500 lbs.
2. If your vehicle is not factory equipped with a hitch, we recommend taking it to a reputable trailer hitch installation shop or your vehicles dealership.

As with any vehicle accessory, please refer to your vehicle owners manual to verify that the GVWR (Gross Vehicular Weight Rating) will not be exceeded, especially if this product will be used in conjunction with other mounted equipment. If equipment is mounted to vehicle with other than stock hardware or components, we the manufacturer cannot and will not be held responsible for damages. Also, check your vehicle owner's manual to be sure that the installation of "aftermarket" accessories will not void the manufacturers' factory warranty.

For installation Blaster 350 series spreaders:



Receiver Mount Installation / Assembly

INSTALLING RECEIVER MOUNT MODEL: 350/350S/750R/750RS

The Blaster 350/350S/750R/750RS is a dedicated, 2", receiver (hitch) mount salt spreader. Prior to installation, be certain that the vehicle receiver is in good working order, is rated for at least a 500 lb. tongue load, and is fastened to the vehicle securely.

CAUTION - The spreader is a large heavy item that should be installed with an assistant. As with any new equipment installation read and understand all instructions prior to starting the job, and do not hurry through it. A correct installation now can save time and money later.

1. Using an assistant remove the spreader unit and all loose components from the packaging and set cover aside until installation is complete. Retain original packaging for storage purposes.
2. Locate the large hitch pin and cotter clip (40) from the hardware package. Set these items aside, as they will be used later during the installation.
3. Inspect the vehicle's receiver tube and check for rust, dirt, or foreign debris that may have collected in it. If there are any blockages clean with compressed air and a wire brush.
4. Apply good quality grease to the inside of the receiver tube, this will prevent rusting and make the spreader easier to remove at the end of the season.
5. The framework will have four 1/2-13 x 3" SS Bolts (29) already installed in the mounting holes for the stinger. Remove the 1/2-13 SS Locknuts (30) and 1/2" SS Flatwashers (31) and apply a light oil to the threads, this will make assembly easier; yet will not affect the locking properties of the safety nuts. Place the hitch assembly over the bolts, replace the nuts and washers and fully tighten.
6. Lift the spreader unit upright (hopper opening facing up) with mounting tube pointed toward the truck.



Receiver Mount Installation / Assembly

7. Slowly slide spreader mounting tube into the vehicles receiver until the through holes in receiver match through holes in spreader. (See note below)
8. Insert the large hitch pin (40) through the receiver tube and spreader mounting tube. Secure with the cotter clip (40).
WARNING – The cotter clip (40) must be in place for safe operation.
9. Place the cover over the hopper and secure clamps on left and right sides.

NOTE:

- The spreader mounting tube has two pre-punched hole sets to provide some adjustment when installing the unit.
- Always use the hole set that places the unit closest to the vehicle but without touching it.

WARNING – Never attempt to drill new holes in the spreader mounting tube, contact your local trailer hitch supplier about relocating or replacing you current hitch, if mounting problems occur.

10. Use the Ratchet Tie Down Strap and Tie Down Hooks to tie spreader to vehicle frame to eliminate any rocking of the spreader.



Spreader Component Identification

Blaster 350/350S

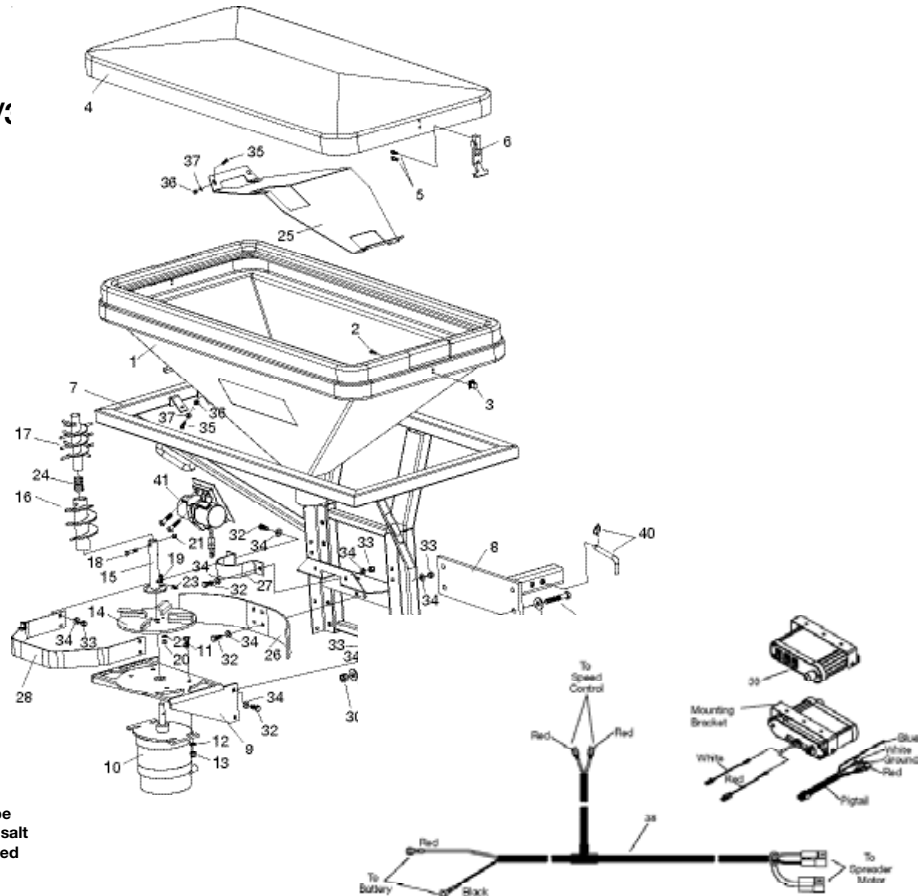

Note: 350S Auger Extension (17) must be removed when using salt only. If it is not removed this may cause the motor to stall.

Spreader Component Identification

Blaster 350/350S

	350	350S	
Item	Part No.	Part No.	Qty. Description
	32000	37000	Blaster Assembly
1	32100	32100	1 • Hopper Assembly
2	22729	22729	2 •• Bolt 1/4-20 x 5/8" SS
3	34407	34407	2 •• Latch Hook
4	34200	34200	1 • Lid Assembly
5	22725	22725	4 •• Bolt 1/4-20 x 3/4" SS
6	34408	34408	2 •• Rubber Latch
7	32200	32200	1 • Frame Assembly
8	35001	35001	1 • Hitch Assembly
9	34101	34101	1 • Motor Mount
10	34102	34102	1 • Motor
11	22730	22730	4 • Bolt 3/8-16 x 1-1/4" SS
12	22735	22735	4 • Locknut 3/8-16 SS
13	22734	22734	8 • Flatwasher 3/8" SS
14	36415	36415	1 • Spinner
15	34011	34011	1 • Auger Center Post
16	34302	34306	1 • Auger
17	-----	34603	1 • Auger Extension
18	22996	22996	1 • Bolt 1/4-20 x 2" SS
19	22725	22725	3 • Bolt 1/4-20 x 3/4" SS
20	22727	22727	3 • Locknut 1/4-20 SS
21	22997	22997	1 • Locknut 1/4-20 SS
22	22724	22724	3 • Flatwasher 1/4" SS
23	22726	22726	1 • Set Screw 5/16" SS
24	22728	22759	1 • Set Screw 3/4-10 x 2 SS

• or •• = Parts indented are included in the carton, bag or assembly under which they are indented.

	350	350S	
Item	Part No.	Part No.	Qty. Description
25	-----	34601	1 • Baffle Plate
26	34401	34401	1 • Deflector
27	34402	34402	1 • Hopper Collar
28	34400	34400	1 • Motor Guard
29	22736	22736	4 • Bolt 1/2-13 x 3" SS
30	22732	22732	4 • Locknut 1/2-13 SS
31	22733	22733	8 • Flatwasher 1/2" SS
32	22737	22737	18 • Bolt 3/8-16 x 1" SS
33	22735	22735	18 • Locknut 3/8-16 SS
34	22734	22734	35 • Flatwasher 3/8" SS
35	22725	-----	2 • Bolt 1/4-20 x 3/4" SS
35	-----	22725	8 • Bolt 1/4-20 x 3/4" SS
36	22727	-----	2 • Locknut 1/4-20 SS
36	-----	22727	6 • Locknut 1/4-20 SS
37	22724	-----	2 • Flatwasher 1/4" SS
37	-----	22724	6 • Flatwasher 1/4" SS
	32218	32218	1 • Carton Accessory Parts
38	34106	34106	1 •• Wire Harness
39	22800	22800	1 •• Controller
40	22731	22731	1 •• Hinge Pin w/Clip
	32216	32216	2 •• Tie Down Hook
	32217	32217	2 •• Ratchet Tie Down Strap
41	-----	34602	1 • Vibrator



Spreader Component Identification



**B1
75**

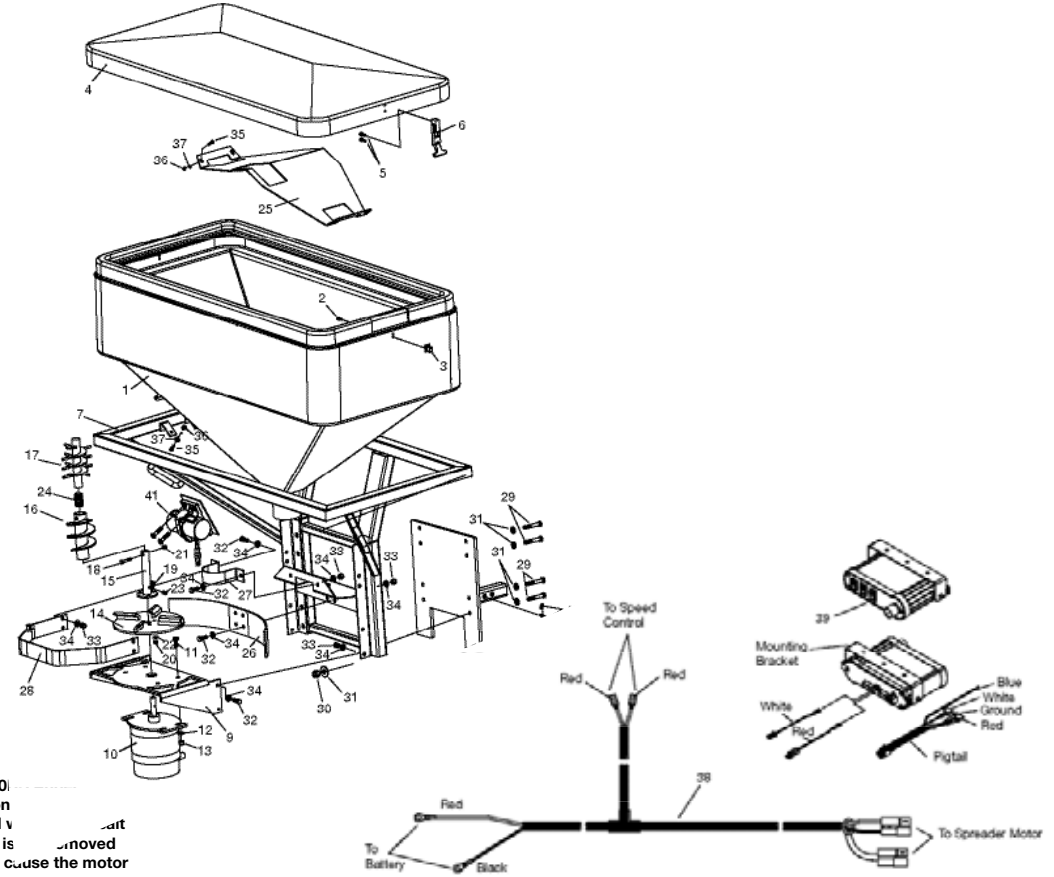

Note: 750i
Extension removed v
only. If it is removed
this may cause the motor to stall.

Spreader Component Identification

Blaster 750R/750RS

750R		750RS				750R		750RS			
Item	Part No.	Part No.	Qty.	Description		Item	Part No.	Part No.	Qty.	Description	
	33750	39010		Blaster Assembly		25	-----	34601	1	• Baffle Plate	
1	33100	33100	1	• Hopper Assembly		26	34401	34401	1	• Deflector	
2	22729	22729	2	•• Bolt 1/4-20 x 5/8" SS		27	34402	34402	1	• Hopper Collar	
3	34407	34407	2	•• Latch Hook		28	34400	34400	1	• Motor Guard	
4	34200	34200	1	• Lid Assembly		29	22736	22736	8	• Bolt 1/2-13 x 3" SS	
5	22725	22725	4	•• Bolt 1/4-20 x 3/4" SS		30	22732	22732	8	• Locknut 1/2-13 SS	
6	34408	34408	2	•• Rubber Latch		31	22733	22733	16	• Flatwasher 1/2" SS	
7	32200	32200	1	• Frame Assembly		32	22737	22737	18	• Bolt 3/8-16 x 1" SS	
8	35010	35010	1	• Hitch Assembly		33	22735	22735	18	• Locknut 3/8-16 SS	
9	34101	34101	1	• Motor Mount		34	22734	22734	35	• Flatwasher 3/8" SS	
10	34102	34102	1	• Motor		35	22725	-----	2	• Bolt 1/4-20 x 3/4" SS	
11	22730	22730	4	• Bolt 3/8-16 x 1-1/4" SS		35	-----	22725	8	• Bolt 1/4-20 x 3/4" SS	
12	22735	22735	4	• Locknut 3/8-16 SS		36	22727	-----	2	• Locknut 1/4-20 SS	
13	22734	22734	8	• Flatwasher 3/8" SS		36	-----	22727	6	• Locknut 1/4-20 SS	
14	36415	36415	1	• Spinner		37	22724	-----	2	• Flatwasher 1/4" SS	
15	34011	34011	1	• Auger Center Post		37	-----	22724	6	• Flatwasher 1/4" SS	
16	34302	34306	1	• Auger			32218	32218	1	• Carton Accessory Parts	
17	-----	34603	1	• Auger Extension		38	34106	34106	1	•• Wire Harness	
18	22996	22996	1	• Bolt 1/4-20 x 2" SS		39	22800	22800	1	•• Controller	
19	22725	22725	3	• Bolt 1/4-20 x 3/4" SS		40	22731	22731	1	•• Hinge Pin w/Clip	
20	22727	22727	3	• Locknut 1/4-20 SS			32216	32216	2	•• Tie Down Hook	
21	22997	22997	1	• Locknut 1/4-20 SS			32217	32217	2	•• Ratchet Tie Down Strap	
22	22724	22724	3	• Flatwasher 1/4" SS		41	-----	34602	1	• Vibrator	
23	22726	22726	1	• Set Screw 5/16" SS							
24	22728	22759	1	• Set Screw 3/4-10 x 2 SS							

• or •• = Parts indented are included in the carton, bag or assembly under which they are indented.



Electrical Installation - Blaster Spreaders

1. Locate the wire harness (38) and begin to route it from the rear of the vehicle to the front. The molded rubber plug indicates the rear of the harness, closest to the spreader. Use frame holes and frame supports as lashing points. Do not attach to fuel or brake lines. Avoid wire-runs along exhaust system or hot engine parts. Melting damage to the harness can occur in the proximity of extreme heat.
2. Mount the rubber plug under the rear bumper. Position this plug toward the center of the vehicle.
3. Place the Harness (38) portion that connects to the battery along the firewall and fender well, but do not connect yet.
4. Drill a 1" diameter hole through the firewall. This hole will be used to route the controller portion of the harness into the vehicle. Before drilling always check to see what is on the other side.
5. Push the controller portion of harness through the hole in the firewall that was previously drilled.
NOTE: The controller end will have 2 plugs on it, but only 1 plug can pass through the firewall at a time.
6. Move to engine compartment. Connect power leads to battery: RED WIRE (+) positive, BLACK WIRE (-) negative. Coat the connections with dielectric grease to prevent corrosion and build up. Check harness marked 'battery' for voltage by temporarily removing the red tape affixed to it.
7. Connect the blue wire from pigtail to brake light. Connect white wire from pigtail to optional vibrator harness if equipped. Connect red wire on pigtail to a 12 volt keyed accessory. Connect black ground wire to ground. Connect white jumper wire to the back of the controller marked motor white wire. Connect red jumper wire to the back of the controller marked battery red wire. The two red wires from the main connector can now be connected to the two jumper wires. (Note: wires will only connect one way) ANY ATTEMPT TO JOIN THE CONNECTORS IMPROPERLY, FOR EXAMPLE MALE TO MALE, WILL NOT ALLOW THE CONTROLLER TO FUNCTION.
8. Select a suitable location to mount the controller. After mounting verify that the power switch is in the off position.
9. Coil excess wire and use wire ties to secure it to a safe location.
10. Mate the plug coming from the spreader unit to the plug previously installed under the rear bumper.
11. Make sure that feed screw/spinner area of the spreader is clear of obstructions. Turn power on at the controller and verify that the spreader is operating in all modes. Looking down on the impeller from the rear of the vehicle, determine that the impeller is turning counter-clockwise. Unit may now be operated.

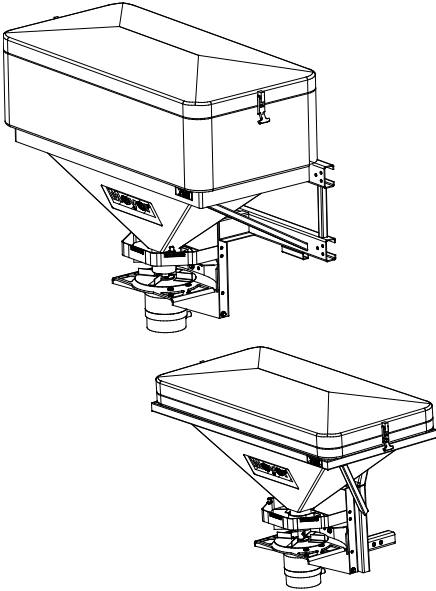

Spreader Operation

Before using the spreader read and understand all aspects of this operators manual.

PREPARATION:

CAUTION - Sweep area clear of foreign objects or obstacles that could cause personal injury. Keep other persons and animals out of area to be spread.

SPREADER LOADING:

Your spreader will come equipped with a cover that will protect your de-icing material from rain or snow; this can be removed simply by detaching the holding clamps on the sides of the hopper.

WARNING – Do not overload vehicle. Below is a chart to calculate weight of materials.

MATERIAL	WEIGHT PER CUBIC FT.
Rock Salt	35-40 lbs.
Coarse Sand	85-90 lbs.

WARNING – NEVER leave materials in hopper for long periods of time as de-icing materials will attract atmospheric moisture and may clump together.

Always replace cover after filling to prevent saturation of material from snow or rain.

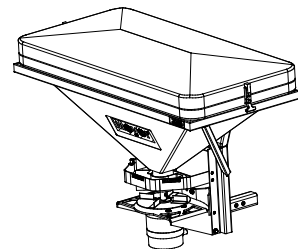
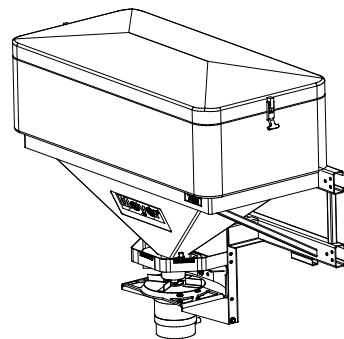

Spreader Operation

OPERATING THE SPREADER:

The controller is equipped with a power on switch, blast switch, vibrate switch and rotary speed control. Once the ignition key is turned to the ON position, the controller face plate will illuminate white indicating that the controller is ready for operation. During operation, face plate color will vary depending on the mode of operation and status of the controller. If the vehicle ignition is shut off while the controller power switch is in the ON or AUTO position the controller will turn off. Once the vehicle ignition is turned back on the controller will not illuminate or turn on unless the controller power switch is first turned off.

To start the spreader, be sure that the vehicle engine is running to prevent battery from wearing down, flip the power switch to position I for normal mode or position II for auto mode. Once power switch is ON, the spreader will power up with 5 full blast for approximately one second then drop to wherever the dial has the speed set at. Adjust the speed of the spreader by rotating the dial clockwise for faster and counterclockwise for slower. The face plate will illuminate greener as the speed increases and will change completely to green at maximum speed.

If auto mode is selected, the face plate color will change to amber, the spreader will power up with 5 full blast for approximately one second then drop to wherever the dial has the speed set at. In this mode, if the brake is applied for more than 5 seconds, the spreader will stop and once the brake pedal is released, spreader will resume its operation.

The blast switch provides momentary full power override. During operation if blast switch is depressed, spreader will go on to full speed and the face plate color will change to blue.

If vibrator switch is flipped to the ON position I, vibrator motor will be activated as long as the switch is maintained at position I and the face plate will illuminate purple. If vibrator auto mode is selected at position II, vibrator motor will activate for 10 seconds every 60 seconds and will cycle the motor ON and OFF as long as the switch is maintained at AUTO position II. Face plate will change color to purple whenever the vibrator motor is activated.

In case there is an overload condition, the face plate will change to red color and the spreader will stop. The Power ON / OFF or AUTO switch will need to be turned OFF to reset the controller.

SPREADING HINTS: Never exceed 10 M.P.H. when spreading. For a wider pass, increase spinner speed. For a heavier pass, drive more slowly. Never operate spreader around people and calculate spread pattern around vegetation.

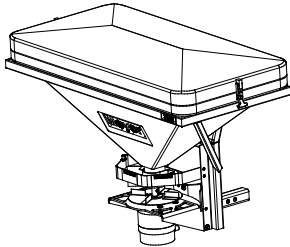
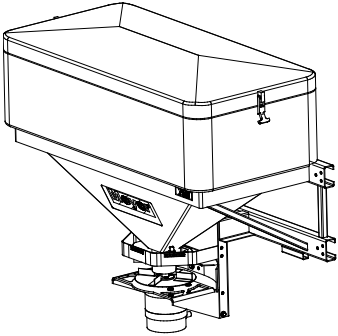

Spreader Maintenance

WARNING – Disconnect power to spreader before servicing.

CAUTION – Do not attempt to service control unit. It is a solid-state electronic device and has no user serviceable parts; any attempt to do so will void warranty.

CAUTION - The electric motor is sealed and should not be taken apart for any reason. Disassembly of the motor will void warranty.

CAUTION – When replacing parts use only Meyer Products approved parts or risk voiding warranty.

Use dielectric grease on all electrical connections, before and after each season and whenever the plugs are disconnected. This will ensure long life for the contacts and prevent corrosion.

Wash unit after each use to prevent material build-up and corrosion.

Periodically inspect the motor seal located around the shaft and look for cracks or splits. If seal is damaged or missing contact the manufacturer for a replacement.

At the end of the season thoroughly clean all parts and paint or oil all bare metal surfaces (except for hopper and spinner which are stainless steel and do not require painting). Using a paste wax on the inside of the hopper will help material flow smoothly. OIL SHAFT AT MOTOR BASE TO PREVENT RUST DURING NON-USE.

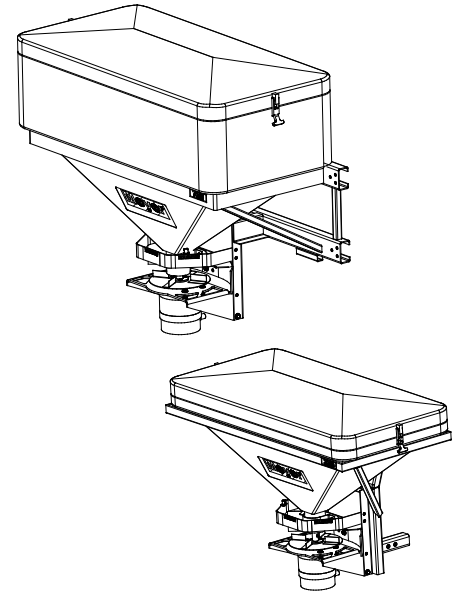

Spreader Troubleshooting

If your spreader is not operating properly, take it to your local Meyer Products Distributor for maintenance or service. However, that is not always possible, so below on this page you will find a troubleshooting guide, which can assist you in determining the problem.

WARNING – Before performing any service read and understand all safety guidelines stated in this manual.

BEFORE CALLING YOUR DEALER:

Be sure all electrical connections are clean and tight.





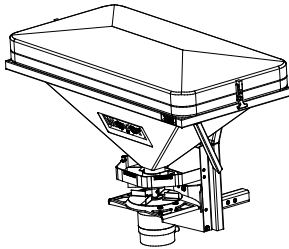
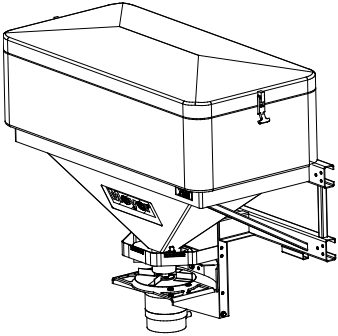

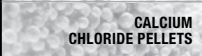
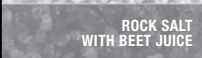
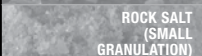
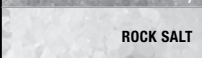
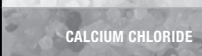

Be sure vehicle power supply is working properly (battery charged)

Check the hopper for a jammed feed screw.

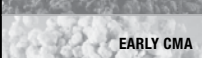

PROBLEM	POSSIBLE CAUSE	SOLUTION
Motor does not run.	<ul style="list-style-type: none"> • Loose electrical connection. 	<ul style="list-style-type: none"> • Check all electrical connections.
Shut Down.	<ul style="list-style-type: none"> • Auger or spinner jammed • Jammed auger. • Poor electrical connections. • Electrical short. 	<ul style="list-style-type: none"> • Carefully remove jammed material. • Carefully remove jammed material. • Clean or replace connectors. • Look for bare or loose wires.
Material will not feed.	<ul style="list-style-type: none"> • No material in the hopper. • Material is wet. • Frozen or coarse material. • Auger loose on motor shaft. <ul style="list-style-type: none"> • Controller bad. 	<ul style="list-style-type: none"> • Fill hopper. • Replace with dry material. • Replace material. • Tighten setscrew on side if auger. There is a flat machined into the motor shaft, this set screw must tighten onto that flat. • Replace controller.

Blaster 350/750 Materials Chart

	CALCIUM CHLORIDE FLAKES	●*
	CALCIUM CHLORIDE PELLETS	●*
	ROCK SALT WITH BEET JUICE	
	ROCK SALT (SMALL GRANULATION)	●
	ROCK SALT	●
	CALCIUM CHLORIDE	●
	ROCK CHIPS	
	BAGGED ICE MELT	●*
	LAVA ROCK	
	EARLY CMA	
	50/50 SAND/SALT MIX	●
	SAND	●*
	PEA GRAVEL	
	SHOULDER GRAVEL	

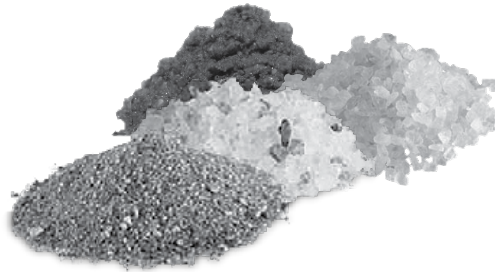

● Approved Material



Spreader Calibration

LANE MILE CALIBRATION (US)

DISCHARGE RATE (pounds discharged per mile)

Control Setting	A	B	C	TRAVEL SPEED AND COMPUTATION MULTIPLIER								
	Shaft RPM (Loaded)	Discharge per Revolution (lbs.)	Discharge per Minute (lb) (A x B)	5 mph (C x 12.00)	10 mph (C x 6.00)	15 mph (C x 4.00)	20 mph (C x 3.00)	25 mph (C x 2.40)	30 mph (C x 2.00)	35 mph (C x 1.71)	40 mph (C x 1.50)	45 mph (C x 1.33)
1												
2												
3												
4												
5												
6												
7												
8												
9												
10												

The actual application rate (*lbs. per lane mile*) on the highway is the discharge rate divided by the number of lanes being treated.

Spreader Calibration Procedure

Calibration is simply calculating the pounds per mile discharged for each control setting at various travel speeds by first counting the number of auger or conveyor shaft revolutions per minute, measuring the weight of salt discharged in one revolution, then multiply the two to obtain discharge per minute, and finally multiplying the discharge per minute by the time it takes to travel 1 mile.

Equipment needed:

1. Scale to weigh salt
2. Salt collection device
3. Marking device
4. Watch with second hand

Calibration steps:

1. Remove spinner assembly.
2. Put partial load of salt in spreader.
3. Mark shaft end of auger.
4. Count number of shaft revolutions per minute at each spreader control setting, record.
5. Collect salt discharged for one revolution, weigh it and deduct the weight of the container. (For greater accuracy, collect salt for several revolutions and divide by that number of revolutions to get the weight for one revolution.)



Spreader Calibration

PARKING LOT CALIBRATION (US)

DISCHARGE RATE (pounds discharged per square foot)

	A	B	C	D	E	F	G	H	I	(lbs. discharged per sq. ft.)			
Control Setting	Shaft RPM (Loaded)	Spread Pattern width (ft.)	Spread Pattern sq. ft. (5 x B) x (5 x B) x (3.14)/2	Discharge per Auger Revolution (lbs.)	Discharge per Minute (lb) (A x C)	5 mph (D x 12.00)	10 mph (D x 6.00)	15 mph (D x 4.00)	20 mph (D x 3.00)	5 mph F/(C x 5280)	10 mph G/(C x 5280)	15 mph H/(C x 5280)	20 mph I/(C x 5280)
1													
2													
3													
4													
5													
6													
7													
8													
9													
10													

The actual application rate (lbs. per sq. ft.) on the parking lot.

Spreader Calibration Procedure

Calibration is simply calculating the pounds per mile discharged for each control setting at various travel speeds by first counting the number of auger or conveyor shaft revolutions per minute, measuring the weight of salt discharged in one revolution, then multiply the two to obtain discharge per minute, and finally multiplying the discharge per minute by the time it takes to travel 1 mile.

Equipment needed:

1. Scale to weigh salt
2. Salt collection device
3. Marking device
4. Watch with second hand

Calibration steps:

1. Remove spinner assembly.
2. Put partial load of salt in spreader.
3. Mark shaft end of auger.
4. Count number of shaft revolutions per minute at each spreader control setting, record.
5. Collect salt discharged for one revolution, weigh it and deduct the weight of the container. (For greater accuracy, collect salt for several revolutions and divide by that number of revolutions to get the weight for one revolution.)



Blaster Series Accessories

Removable Hopper Screen

The removable, welded-steel mesh hopper screen prevents large chunks of material into the hopper and improves material flow. Available in 2" x 2" or ½" x ½" mesh.

Part # 34700 (2" X 2" Mesh)

Part # 34701 (½" X ½" Mesh)



Sander/Vibrator Kit

Standard on 350S and 750S models, lets you spread a 50/50 blend of rock salt and sand or sand only. Includes extended auger, vibrator, vibrator mounting plate, baffle plate and vibrator harness.

Part # 34600



Spiral Auger

Is perfect for spreading free flowing material such as rock salt, calcium chloride and other ice melt materials. Comes standard on all models except 350S and 750S.

Part # 34306



Patented No-Leak Auger Kit (Course Material)

This brush auger kit prevents course material like free-flowing #2 rock salt from leaking through the throat of the spreader. It also provides a uniform salt distribution pattern.

Part # 34300



Patented No-Leak Auger Kit (Fine Material)

This brush auger kit prevents fine free-flowing material like fine salt from leaking through the throat of the spreader. It also provides a uniform salt distribution pattern).

Part # 34301



Salt Auger Kit

This auger is designed to provide maximum performance when spreading dry, free-flowing salt without clogging or tunneling. Includes all mounting hardware. Recommended to be used with the sander/vibrator kit (#34600) and flow gate kit (#34900).

Part # 34118



Chain Auger Kit

Helps break up material and provide excellent flow when spreading sand, fine gravel and salt mixes. Includes all mounting hardware. Recommended to be used with the sander/vibrator kit.

Part # 34109



Flow Gate Control

The Meyer Flow Gate control system allows the end-user to set the material flow rate based on the material being used. The unit is made of 100% aluminum and will not rust, is lightweight and extremely easy to install. The unit clamps to the throat of the spreader. Simply clamp the flow gate unit onto the discharge throat of the unit, tighten the clamping screws, and the flow gate teeth bite into the discharge throat securing the control to the spreader. Salt is very expensive, and the flow gate control maximizes material discharge eliminating waste.

Part # 34900



Blaster Series Accessories

Motor Guard & Integrated Storage Stand

The electric motor is arguably the most important aspect of the tailgate spreader. To protect this investment, Meyer has developed a bolt-on heavy-duty tubular motor guard. For receiver hitch models, it also serves as a storage stand when spreader is removed from the vehicle.

Part # 36407

3-point Hitch 2" Receiver Spreader Mount

This mount allows a 2" receiver hitch spreader to be mounted to a standard category 1, 3-point hitch.

Part # 36500

EZ-Swing Gate

Kit allows empty Blaster to swing freely from the tailgate and allows convenient tailgate access while Blaster is attached. Used with Blaster 350, 350S, 750R & 750RS

Part # 35100

Dump Truck Mount

Kit used to mount a Blaster 750 and 750S to a dump truck.

Part # 35300

Fixed Mount

Kit used to mount a Blaster 750 and 750S.

Part # 35200



Flatbed Mount

Kit used to mount a Blaster 750 and 750S to a flat bed vehicle.

Part # 35400



Flatbed Utility Mount

Kit used to mount a Blaster 350, 350S, 750R and 750RS.

Part # 35002



Receiver Hitch Spreader Lock

Prevent your valuable spreader investment from theft with our stainless steel lock. The 3" locking pin conveniently replaces the existing pin bolt, works on all standard 2"x 2" receiver hitch spreader mounts. The quick disconnect/connect design makes changes fast and easy. Lock comes with a set of keys (2) complete with instructions for quick and easy installation.

Part # 07695C

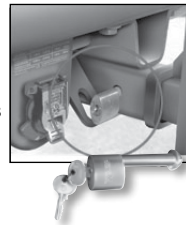

Vibrator Kit

(Available option for models 350 & 750)

Standard on 350S & 750S models, lets you spread a 50/50 blend of rock salt and sand or sand only. Includes extended auger, vibrator, vibrator mounting plate, baffle plate and vibrator harness.

Part # 34600



Blaster Series Accessories

Spreader Controller (standard)

The Meyer Spreader Controller (patent-pending) is the most reliable and convenient controller on the market. This lightweight and compact unit comes standard with many easy-to-use, performance-enhancing features such as:

- **Auto Spinner Stop Mode** – If selected, when the brake is depressed for five seconds, the spinner automatically stops, thus saving your precious salt.
- **Auto Vibrate Mode** – If selected, the vibrator will automatically activate for 10 seconds every 60 seconds; this keeps the material agitated and ready for application.

The unit also boasts convenient features such as back-lit controls for visual clarity at night, and a variable-speed dial that easily controls spinner speed. When it comes to serviceability, this controller is two steps ahead of the competition. The Controller also monitors the motor performance, if the controller senses that the motor is not operating it automatically shuts down the system allowing the operator to inspect the system. In anticipation of unwanted amp surges, the unit comes standard with easy-to-replace automotive-type fuses. The Meyer Controller requires minimal installation and comes with all mounting hardware and instructions for easy installation.

Part # 22800

The Big Yellow Box

The Meyer Big Yellow Box is the perfect companion for your fall, spring, summer and winter needs. The unit features 8 cubic feet of storage and is made of double walled polymer that is virtually indestructible. Perfect for storing: Sand/Salt, Power Tools, Sports equipment, Pool supplies and tools or garbage. Unit will not rust and comes lock-ready. (Lock is sold separately) Forklift pockets are built-in to move the unit when full of material. Unit is 32"W x 23"D x 30"H. No assembly required.

Part # 32403



Spreader Rear Work Lights

Lighting the work area behind the truck is becoming as important as lighting the work area in front of the truck. Meyer offers two options for rear lighting, a LED and Halogen offering:

- **LED Rear Light Package** – Includes a LED work light and mounting hardware. The heavy-duty industrial LED work light mounts conveniently to any rear location and brightens up the rear of the truck. The light is fully adjustable and plugs in to a standard trailer hitch power cord.
- **Halogen Rear Light Package** – Includes a Halogen work light and mounting hardware. The halogen work light conveniently mounts to any rear location and brightens up the rear of the truck. The light is fully adjustable and plugs in to a standard trailer hitch power cord.

Each kit consists of one work light and comes fully assembled with mounting hardware and instructions.

Part # 34610 (LED Rear Light Package)

Part # 34609 (Halogen Rear Light Package)

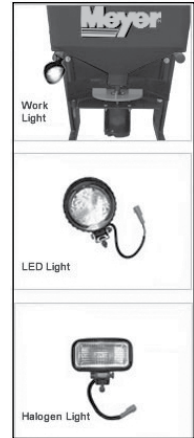

Meyer Pro Edge Snow Rake

This Meyer accessory is made from a foam-like polyethylene. The squeegee-like head never gets brittle, and doesn't absorb water, so it remains pliable to safely contour to your vehicle and efficiently remove snow. The pliable head also means no more scratching your vehicle's finish. It comes with a long handle so no matter how large your vehicle, the Meyer Pro Edge Snow Rake can reach the area you need to scrape.

Part # 38197

Part # 38198 (10/case)



Blaster Series Accessories

Hotshot Hand-held Crank Spreader

This professional spreader holds up to 5 lbs. of ice melt products. It's easy to use: set the dial, pull the trigger then rotate the lever in a clockwise position. To stop material output, simply let go of the trigger. Spreads ice-melt, fertilizer or seed for true four-season performance.

Part # 38195 **Part # 38196 (6/case)**



Driveway Markers

Meyer Driveway Markers are 4' long, made of sturdy ¼" fiberglass to withstand winter elements. They are flexible, designed to bend virtually in half and return to their original position. Designed of highly reflective fluorescent orange along with a specialized reflective tape make them highly visible during a storm or after dark.

Part # 03240 (Bundle of 100) **Part # 03242 (Insertion Tool)**



Suspension Enhancement

To improve the ride and overall performance of your vehicle, Meyer offers Timbren Suspension Enhancement kits. Timbren suspension system works in conjunction with your vehicle's factory suspension system to provide added support in the front or rear of your vehicle. Timbren's rubber cushioned products reduce the harsh ride caused by adding leaf springs or helper springs. Timbren suspension kits come complete as a set (2) and include installation instructions. May require professional installation.



Meyer Dielectric Grease

Prevent your valuable system from the harsh elements of the winter with Meyer's dielectric grease. Meyer's dielectric grease is specially formulated to coat and protect electrical connections from deteriorating elements such as salt and road grime. It is recommended to coat all electrical connections prior to winter and each time you re-connect to ensure optimal performance. Grease comes per each, 2.7oz tube

Part # 15632



Meyer Sno-Flo Industrial Paint

Our specially formulated paint is designed to improve snow-rolling action and withstand the harsh operational environment. Meyer Yellow, Black & White Primer is available in aerosol spray cans (12/case) and Meyer Yellow Brush Paint is available in 1 quart cans (4/case) that can be shipped via UPS.

Part # 07181 Brush Yellow

Part # 08755 Brush Yellow (4/1qt cans/case)

Part # 07027 Spray Yellow

Part # 08677 Spray Yellow (12 cans/case)

Part # 07164 Spray Black (12 cans/case)

Part # 08676 Spray Black (12 cans/case)

Part # 07418 Spray White Primer

Part # 08841 Spray White Primer (12 cans/case)



Meyer Coolube

Maintain Meyer equipment with our premium quality, multipurpose, non-soap based grease. Meyer Coolube is specifically formulated to provide better lubrication in harsh conditions, perfect for higher speeds and lower temperatures. It holds up over a wider temperature range (-40 degrees Fahrenheit to 440 degrees Fahrenheit) plus it works wet or dry. Available in 14 oz. tubes or 11 oz. aerosol cans.

Part # 15181 Tube **Part # 15182 Tube (10 tubes/case)**

Part # 15185 Aerosol **Part # 15186 Aerosol (12 cans/case)**



Meyer Chain & Cable Lube

Maintain Meyer equipment with our aerosol Chain & Cable lube. It is specially formulated to lubricate, preserve and protect chains and cables. This transparent heavy-duty dry film lubricant is formulated with the latest synthetic additives to ensure maximum penetration and protection against corrosion. Once applied, the solvent evaporates leaving behind a film that will not attract dust or wash off. Available in 11 oz. aerosol cans.

Part # 15183 **Part # 34609 (12 cans/case)**



Meyer® Blaster Spreader Warranty

Meyer Products, LLC, warrants to the original purchaser of Meyer® brand products that they will be free from defects in materials or workmanship, with the exceptions stated below. No person is authorized to change this warranty or to create any additional warranty on Meyer® products.

This warranty runs for a period of two years from the date of purchase on any purchase of a complete Blaster Spreader Package. If the Package is registered on-line at www.meyerproducts.com within sixty (60) days of purchase, your warranty for the Package will be extended for a period of three years. All foregoing warranties apply only to an original purchaser of the product if the product is installed by an authorized Distributor/Sub-Distributor and terminate if the product is sold or otherwise transferred. Some states do not allow limitations on how long an implied warranty lasts, so the above limitation may not apply to you.

- Problems caused by failure to follow the product instructions, failure to maintain the product as described in the Operator's Manual;
- Problems caused by contamination or damage resulting from rust, corrosion, freezing or overheating;
- Paint, or expendable spreader parts such as Auger or Spinner
- Damage to any vehicle to which the products are mounted;
- Damage caused by usage that is not in accordance with product instructions (use of the spreader for any purpose other than spreading salt/sand is considered misuse and abuse);
- Any spreader, or any part, component, or assembly thereof, which has been modified or altered;
- Problems caused by using accessories, parts, or components not supplied by Meyer Products;
- Cost of tax, freight, transportation or storage charges, environmental charges, solvents, sealants, lubricants or any other normal shop supplies.
- Problems caused by collision, fire, theft, vandalism, riot, explosion, lightning, earthquake, windstorm, hail, water, flood, or any other Acts of God;
- Liability for damage to property, or injury to, or death of any person arising out of the operation, maintenance or use of the covered product;
- Products with missing or altered serial numbers;

The original purchaser's sole and exclusive remedy against Meyer Products and its Distributors and Sub-Distributors, and Meyer Products' sole obligation for any and all claims, whether for breach of contract, warranty, tort (including negligence) or otherwise shall be limited to providing, through its authorized Distributor/Sub-Distributor network, all labor and/or parts necessary to correct such defects free of charge. Any cost incurred in returning the product to an authorized Meyer® Distributor/Sub-Distributor is the responsibility of the original purchaser. ALL EXPRESS AND IMPLIED WARRANTIES FOR THE PRODUCT, INCLUDING, WITHOUT LIMITATION, ANY IMPLIED WARRANTIES OF MERCHANTABILITY AND FITNESS FOR A PARTICULAR PURPOSE, ARE LIMITED IN TIME TO THE TERM OF THE LIMITED WARRANTY PERIOD. NO WARRANTIES, WHETHER EXPRESS OR IMPLIED, WILL APPLY AFTER THE LIMITED WARRANTY PERIOD HAS EXPIRED. Meyer Products disclaims liability beyond the remedies provided for in this limited warranty, and disclaims all liability for incidental, consequential, and special damages, including, without limitation, any liability for third-party claims against you for damages, for products not being available for use, or for lost profits. Meyer Products' liability will be no more than the amount you paid for the product that is the subject of a claim; this is the maximum amount for which we are responsible. Some states do not allow the



Meyer offers a complete line of spreaders for any application and vehicle size. Go to www.MeyerProducts.com for more information.

exclusion or limitation of incidental or consequential damages, so the above limitation or exclusion may not apply to you. A complete Blaster Spreader Package consists of the Spreader Assembly, operating controller, Spreader Frame and all related items. Structural elements consist of the Spreader Frame, Mounting and Poly Hopper.

Meyer Products will repair any product that proves to be defective in materials or workmanship. In the event repair is not possible or practical (as determined by Meyer Products in its sole discretion), Meyer Products will either replace the product with a new product of similar model and price, or refund the full purchase price, as determined by Meyer Products.

Customer must keep the complete Blaster Spreader Package serviced/maintained as recommended by Meyer Products. A written record of service must be maintained, along with receipts for maintenance materials purchased. A copy of the maintenance record and pertinent receipts may be requested in the event of a claim.

In order to obtain service under this warranty, the original purchaser must:

- Use all reasonable means to protect the complete Blaster Spreader package from further damage;
- Return the claimed defective part to the Meyer® Distributor/Sub-Distributor from whom the product was purchased or to any authorized Meyer® Distributor/Sub-Distributor, transportation and freight charges prepaid. Only Meyer® Distributors/Sub-Distributors are authorized to perform the obligations under this warranty. For the address and telephone number of the Meyer® Distributor/Sub-Distributor nearest you, check the telephone directory, go to www.meyerproducts.com, write us at the address below, or call (216) 486-1313 for assistance;
- Provide maintenance record and receipts for required maintenance, if requested;
- Allow inspection of damaged parts and/or complete Blaster Spreader package if deemed necessary by Meyer Products.
- It is the responsibility of the original purchaser to establish the warranty period by verifying the original delivery date. A bill of sale/sales receipt, cancelled check or some other appropriate payment record may be kept for that purpose.

This warranty gives you specific legal rights, and you may also have other rights which vary from state to state.

How to register your Meyer Blaster Spreader to receive the ROC Solid Warranty Go to www.meyerproducts.com and click on the link to register your plow. Fill out the information on the form as required.



Meyer offers a complete line of spreaders for any application and vehicle size. Go to www.MeyerProducts.com for more information.

Dealer/Distributor:

Meyer Spreaders are protected by one or more of the following patents: 6698997, CA 2,415,540 C, 7588195, 8448882, 8505837, 8523086, 8657208, 6186731, 6,793,154 B2, 6722590, 6715703, 6978952, 6932287, 8505838, 8827002, 5842649, CA 2,435,106 C, 6364598.



Meyer Products, LLC
18513 Euclid Avenue
Cleveland, Ohio 44112

216-486-1313

www.meyerproducts.com